

# TANDEMBOX – Auszugssystem

- ▶ TANDEMBOX intivo – Grundelement
- ▶▶ Standardkorpus



## Frontauszug – BOXCOVER – D



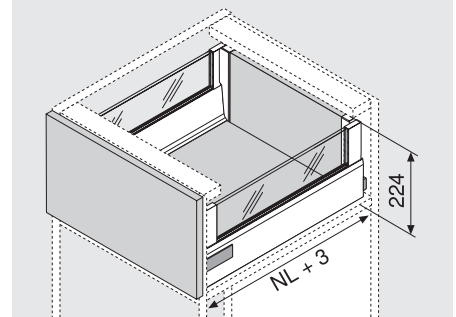

- Verdeckter, gesteuerter Vollauszug
- Mit BOXCOVER und Einschubelement
- TANDEM inside – für schwebelichten Lauf, ein Möbelleben lang
- Zargen aus Stahl seidenweiß (SW), Stahl terrasschwarz (TS), Edelstahl (Inox)
- Werkzeuglose Frontmontage
- 3-dimensionale Frontverstellung
- Mit integrierter **BLUMOTION** für sanftes und leises Schließen, kombinierbar mit **SERVO-DRIVE**
- Oder mit integrierter **TIP-ON**-Funktion für grifflose Fronten

### Platzbedarf



NL Nennlänge

### Bestellinformation

1  Korpus­schi­en links/rechts							2  Zargen und Abdeckkappen links/rechts			
Nennlänge NL	BLUMOTION *			TIP-ON **			Nennlänge NL	SW TS Inox		
	30 kg	50 kg	65 kg	20 kg	30 kg	50 kg		SW	TS	Inox
270 mm	558.2701B			559.2701T			270 mm	358L2702SA2	358L2702IA2	
300 mm	558.3001B			559.3001T			300 mm	358L3002SA2	358L3002IA2	
350 mm	558.3501B01				559.3501T		350 mm	358L3502SA2	358L3502IA2	
400 mm	558.4001B01				559.4001T		400 mm	358L4002SA2	358L4002IA2	
450 mm	558.4501B01	559.4501B	556.4501B			559.4501T	450 mm	358L4502SA2	358L4502IA2	
500 mm	558.5001B	559.5001B	556.5001B			559.5001T	500 mm	358L5002SA2	358L5002IA2	
550 mm	558.5501B	559.5501B	556.5501B			559.5501T	550 mm	358L5502SA2	358L5502IA2	
600 mm		559.6001B	556.6001B			559.6001T	600 mm	359L6002SA2	359L6002IA2	
650 mm		559.6501B	556.6501B			559.6501T	650 mm	359L6502SA2	359L6502IA2	

\* Für **SERVO-DRIVE** geeignet

\*\* Bestellinformation siehe TIP-ON für TANDEMBOX

Individuell bedruckte Abdeckkappen ab 1000 Stk.

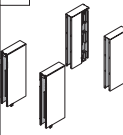
9  BOXCOVER links/rechts	SW TS Inox
	Z36L002G.S Z36L002G.I

9a  Einschubelement aus Glas (seitlich)	Z37GxxxD
Glas	

3  Rückwandhalter links/rechts	Z30D000SL
seidenweiß, terrasschwarz, vernickelt	
Stahl	

4  Frontbefestigung	
Schraubversion	2 x ZSF.5220
EXPANDO-Version	2 x ZSF.532E

